

SERENITY HOT TUBS OWNER'S MANUAL



HYDROPOOL
hot tubs • swim spas



Hydropool Inc.
335 Superior Blvd.
Mississauga, ON, Canada L5T 2L6
Tel: 905.565.6810
Toll Free: 1.800.465.2933
Fax: 905.565.6820
Email: info@hydropoolhottubs.com
www.hydropoolhottubs.com

Contents subject to change without notice

2023

Models Covered	Domestic Model Codes	Export Model Codes
Serenity 45L	NOT APPLICABLE	HSE45L
Serenity 4300	HS4300	HSE4300
Serenity 4500	HS4500	HSE4500
Serenity 5900	HS5900	HSE5900
Serenity 6600	HS6600	HSE6600
Serenity 6800	HS6800	HSE6800
Serenity 6900	HS6900	HSE6900

TABLE OF CONTENTS

Letter of introduction	4	Optional Variable Air Therapy System Control	23
Important User Safety Instructions	5	Optional Hydroclear Pure Water System	24
Warnings	6	UV-C Lamp Replacement	25
Hyperthermia	6	Hot Tub Water Balance	26
Choosing the Right location	7-8	General Overview	26
Indoor Locations	7	Initial Fill	27
Outdoor Locations	7	Glossary of Common Water Maintenance Terms	28
General Installation Considerations	8	Water Balance Summary for your Hot Tub (chart)	29
Special Considerations	9	Water Balance Troubleshooting	29-30
Indoor Installations	9	Routine Hot Tub Maintenance	31
Outdoor Installations	9	Daily, Weekly, Monthly, Quarterly	31
Site Preparation	9-11	Cartridge Filter - Removal, Cleaning, Re-installation	32
Above Ground Installations	9	Changing your Hot Tub Water	32
In-ground & Partial In-ground Installations	10	Water Softeners	32
Equipment Accessibility & Protection	11	Each Time Before Filling the Spa	33
Unloading/Handling Your Hot Tub	11	Serenity Filter Grill And Leaf Bag	34
Important Electrical Safety Instructions	12	Cleaning the Acrylic Surface	35
G.F.C.I./R.C.D. Application Guideline	12	Safety Hard Cover	35
Wire Size	13	Protecting your Cabinet Wood Finish	36
North America G.F.C.I. Installation Diagram	14	Soft Stride Floor System	36
Europe R.C.D. Installation Diagram	15	Winterizing your HydroPool Hot Tub	37
Filling, Checking and Starting your Hot Tub	16	What to do in the event of	
Pump Priming/Releasing an Air Lock	17	Power Fluctuations.	38
HydroPool Serenity Control Systems		Cold Weather Power Failure	38
North America / Europe	18-23	Wiring Diagrams (in.ye-3)	39-40
4300/4500/6600/SE45L Controls	19		
5900/6800 and 6900 Series Controls	20		
Topside Control Panel Display Messages	23		

NOTE: Product specifications, warnings and labels are subject to change without notice. This user's manual should be used as a guide only. For further information, please contact your independent HydroPool dealer.

On behalf of everyone at the company, we thank you for your decision to purchase a HydroPool hot tub.

Recognized for quality worldwide, we are confident that your new hot tub will provide you, your family and friends, with years of enjoyment and fulfill all your hydrotherapy needs.

HydroPool hot tubs are not only healthful and relaxing, they can even add value to your home.

Please take the time to carefully read and understand all the safety, installation and operating instructions in this manual before electrically connecting your hot tub and adding water.

The following pages contain valuable information and pointers that will save you both time and money, as well as help you to simplify upkeep and maintenance.

Since we manufactured our first hot tub in 1985, the HydroPool team has been dedicated to producing a quality product catering to maximum hydrotherapy, comfort, energy efficiency and ease of operation.

We are confident that as you become more familiar with the various safety and maintenance features of your new hot tub you will be satisfied that you made the right decision in purchasing a HydroPool hot tub.

Happy hot tubbing...



David Jackson



SAVE THESE INSTRUCTIONS

IMPORTANT SAVE THESE INSTRUCTIONS

Your physiological response to hot water is subjective and depends on your age, health, and medical history. If you don't know your tolerance to hot water, or if you get a headache, or become dizzy or nauseous when using your hot tub, get out and cool off immediately.



WARNING

1. **CHILDREN SHOULD NOT USE SPAS OR HOT TUBS WITHOUT ADULT SUPERVISION.**
2. **DO NOT USE SPAS OR HOT TUBS UNLESS ALL SUCTION GUARDS ARE INSTALLED TO PREVENT BODY AND HAIR ENTRAPMENT.**
3. **PEOPLE USING MEDICATIONS AND/OR HAVING ANY ADVERSE MEDICAL HISTORY SHOULD CONSULT A PHYSICIAN BEFORE USING A SPA OR HOT TUB.**
4. **PEOPLE WITH INFECTIOUS DISEASES SHOULD NOT USE A SPA OR HOT TUB.**
5. **TO AVOID INJURY, EXERCISE CARE WHEN ENTERING OR EXITING THE SPA OR HOT TUB.**
6. **DO NOT USE DRUGS OR ALCOHOL BEFORE OR DURING THE USE OF A SPA OR HOT TUB, TO AVOID UNCONSCIOUSNESS AND POSSIBLE DROWNING.**
7. **PREGNANT OR POSSIBLE PREGNANT WOMEN SHOULD CONSULT A PHYSICIAN BEFORE USING A SPA OR HOT TUB.**
8. **WATER TEMPERATURE IN EXCESS OF 38°C (100°F) MAY BE INJURIOUS TO YOUR HEALTH.**
9. **BEFORE ENTERING THE SPA OR HOT TUB, MEASURE THE WATER TEMPERATURE WITH AN ACCURATE THERMOMETER.**
10. **DO NOT USE A SPA OR A HOT TUB IMMEDIATELY FOLLOWING STRENUOUS EXERCISE.**
11. **PROLONGED IMMERSION IN A SPA OR HOT TUB MAY BE INJURIOUS TO YOUR HEALTH.**
12. **DO NOT PERMIT OR USE ELECTRIC APPLIANCES (SUCH AS LIGHT, TELEPHONE, RADIO OR TELEVISION) WITHIN 1.5M (5FT) OF THIS SPA OR HOT TUB.**
13. **CHILDREN SHOULD NOT ENTER A HOT TUB WHERE THE WATER TEMPERATURE EXCEEDS BODY TEMPERATURE (37°C / 98.6°F).**
14. **DO NOT ALLOW CHILDREN TO SUBMERGE THEIR HEAD UNDER WATER.**
15. **NEVER OPERATE THE HOT TUB PUMP AT HIGH SPEED WITHOUT HAVING ALL SUCTION AND RETURN LINES OPEN.**
16. **ALWAYS KEEP THE HARDCOVER INSTALLED AND LOCKED WHEN THE HOT TUB IS NOT IN USE.**
17. **TEST THE GFCI (GROUND FAULT CIRCUIT INTERRUPTER) MONTHLY.**
18. **POST EMERGENCY PHONE NUMBERS FOR POLICE, FIRE DEPARTMENT, AND AMBULANCE AT THE NEAREST PHONE.**
19. **TO REDUCE THE RISK OF INJURY**
 - **THE WATER IN A SPA SHOULD NEVER EXCEED 40°C (104°F). WATER TEMPERATURES BETWEEN 38°C (100°F) AND 40°C (104°F) ARE CONSIDERED SAFE FOR A HEALTHY ADULT. LOWER WATER TEMPERATURES ARE RECOMMENDED FOR YOUNG CHILDREN AND WHEN SPA USE EXCEEDS 10 MINUTES.**
 - **SINCE EXCESSIVE WATER TEMPERATURES HAVE A HIGH POTENTIAL FOR CAUSING FETAL DAMAGE DURING THE EARLY MONTHS OF PREGNANCY, PREGNANT OR POSSIBLY PREGNANT WOMEN SHOULD LIMIT SPA WATER TEMPERATURES TO 38°C (100°F).**
 - **BEFORE ENTERING A SPA, THE USER SHALL MEASURE THE WATER TEMPERATURE SINCE THE TOLERANCE FOR WATER TEMPERATURE-REGULATING DEVICES VARIES.**
 - **THE USE OF ALCOHOL, DRUGS, OR MEDICATION BEFORE OR DURING SPA USE MAY LEAD TO UNCONSCIOUSNESS, WITH THE POSSIBILITY OF DROWNING.**
 - **OBESSE PERSONS AND PERSONS WITH A HISTORY OF HEART DISEASE, LOW OR HIGH BLOOD PRESSURE, CIRCULATORY SYSTEM PROBLEMS OR DIABETES SHOULD CONSULT A PHYSICIAN BEFORE USING A SPA.**
 - **PERSONS USING MEDICATION SHOULD CONSULT A PHYSICIAN BEFORE USING A SPA SINCE SOME MEDICATION MAY INDUCE DROWSINESS WHILE OTHER MEDICATION MAY EFFECT HEART RATE, BLOOD PRESSURE AND CIRCULATION.**

SAVE THESE INSTRUCTIONS
IMPORTANT SAVE THESE INSTRUCTIONS

Your physiological response to hot water is subjective and depends on your age, health, and medical history. If you don't know your tolerance to hot water, or if you get a headache, or become dizzy or nauseous when using your hot tub, get out and cool off immediately.



CAUTION

1. MAINTAIN WATER CHEMISTRY IN ACCORDANCE WITH THE MANUFACTURER'S INSTRUCTIONS.



DANGER

1. RISK OF ACCIDENTAL DROWNING. EXTREME CAUTION MUST BE EXERCISED TO PREVENT UNAUTHORIZED ACCESS BY CHILDREN. TO AVOID ACCIDENTS, ENSURE THAT CHILDREN CAN'T USE THE SPA UNLESS THEY ARE SUPERVISED AT ALL TIMES.
2. RISK OF INJURY. THE SUCTION FITTINGS IN THIS SPA ARE SIZED TO MATCH THE SPECIFIC WATER FLOW CREATED BY THE PUMP. SHOULD THE NEED ARISE TO REPLACE THE SUCTION FITTINGS OR THE PUMP, BE SURE THAT THE FLOW RATES ARE COMPATIBLE. NEVER OPERATE THE SPA IF THE SUCTION FITTINGS ARE BROKEN OR MISSING. NEVER REPLACE A SUCTION FITTING WITH ONE RATED LESS THAN THE FLOW RATE MARKED ON THE ORIGINAL SUCTION FITTING.
3. RISK OF ELECTRIC SHOCK. INSTALL AT LEAST 1.5M (5FT) FROM ALL METAL SURFACES. AS AN ALTERNATIVE, A SPA MAY BE INSTALLED WITHIN 1.5M (5FT) OF METAL SURFACES IF EACH METAL SURFACE IS PERMANENTLY CONNECTED BY A MINIMUM 8 AWG (8.4 mm²) SOLID COPPER CONDUCTOR TO THE WIRE CONNECTOR ON THE TERMINAL BOX THAT IS PROVIDED FOR THIS PURPOSE.
4. RISK OF ELECTRIC SHOCK. DO NOT PERMIT ANY APPLIANCE, SUCH AS A LIGHT, TELEPHONE, RADIO, OR TELEVISION, WITHIN 1.5M (5FT) OF THE SPA.

HYPERTHERMIA

Since your hot tub can be set to reach temperatures of 40°C (104°F), users should be aware that extended submersion in water that exceeds normal body temperature can lead to hyperthermia.

The causes, symptoms and effects of hyperthermia may be described as follows:

Hyperthermia occurs when the internal temperature of the body reaches several degrees above the normal body temperature of 37°C (98.6°F). The symptoms of hyperthermia include drowsiness, lethargy, and an increase in the internal temperature of the body.

The effects of hyperthermia include:

- Unawareness of impending hazard
- Failure to perceive heat
- Failure to recognize the need to exit the hot tub
- Physical inability to exit the hot tub
- Fetal damage in pregnant woman
- Unconsciousness resulting in the danger of drowning

If you sense any of the symptoms of hyperthermia, safely exit the hot tub immediately.



WARNING

THE USE OF ALCOHOL, DRUGS OR MEDICATION CAN SIGNIFICANTLY INCREASE THE RISK OF FATAL HYPERTHERMIA.

CHOOSING THE RIGHT LOCATION

Your HydroPool hot tub can be installed indoors or out, on the ground, in the ground or half-and-half. The following information will assist you in choosing the right location for your individual needs. When making your decision, always remember that hot tubs can be enjoyed year-round, indoors or out, regardless of the climate. Many HydroPool owners report that their favourite time to use a hot tub is in the cooler fall and winter months, while others praise the enjoyment of using their hot tub in the warmer spring and summer months.

INDOOR LOCATIONS

If members of your family are not cold weather enthusiasts, or if your backyard or patio area is not suitable for a hot tub installation, then an indoor location for your hot tub may be your best or only choice. You may wish to create an exercise/spa area in your home, or install your hot tub in a glass solarium or four-season room adjoining your home. Indoor installations not only add a unique look and appeal to your home, they provide the privacy and controlled climate to ensure that use and enjoyment of your hot tub is maximized. If you should choose an indoor location, you will find further information as outlined in the section **“SPECIAL CONSIDERATIONS FOR INDOOR INSTALLATIONS”**



OUTDOOR LOCATIONS

For a variety of reasons, outdoor locations are a far more popular choice. Some of the reasons include:

- **Limited indoor space**
- **Delivery complications due to door openings, stairwells, etc.**
- **Limited budget (indoor installations usually also involve interior home renovations)**
- **Desire for an outdoor entertainment center**
- **Hot tub is being installed adjacent to an existing or planned swimming pool**
- **Concerns over splashing water inside the home**

For those who choose an outdoor location, hot tub operating temperatures can be adjusted to match the season.

In colder months, many owners will operate their hot tub in the range of 38-40°C (100 -104°F).

During warmer months, an operating temperature of 36-37°C (97-99°F) will provide a refreshing retreat. If you should choose an outdoor location, you will find further information as outlined in the section

“SPECIAL CONSIDERATIONS FOR OUTDOOR INSTALLATIONS”

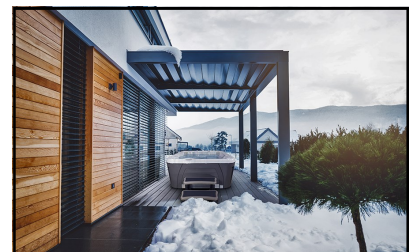

GENERAL INSTALLATION CONSIDERATIONS

1. Your **HYDROPOOL** hot tub is a self-contained pre-plumbed unit, so that no on-site plumbing connections to the residential water supply or drain are required.
2. Ensure that your **HYDROPOOL** hot tub is properly supported by either a level concrete pad, or a properly constructed deck capable of supporting 1220 kg/m² (250 lbs./ft.²). If there is a possibility that the pad could shift by freezing/thawing ground movement (such as in clay regions, and/or areas with high water tables) concrete footings extending below the frost line are recommended.
3. Decking should be chosen and constructed in a manner that minimizes the chance of slipping or falling.
4. If you do not have a factory installed insulated cabinet, it is assumed that you are building your own custom cabinet, tiling or decking.

Please consider the following:

- a) Your **HYDROPOOL** hot tub is self-supporting on its base. The cabinet should be decorative only, not for support. Never suspend the hot tub from the deck or cabinet.
 - b) Where the hot tub is not equipped with a factory installed cabinet, it is the installer's responsibility to ensure all electrical equipment is **completely weather protected** and meets all of the regulatory requirements.
 - c) Always provide adequate access for servicing the support equipment.
 - d) Decking must be constructed to allow repair access around the entire hot tub.
 - e) In remote equipment or no-cabinet installations, you may add extra insulation, but the equipment area must have adequate cross-flow ventilation.
5. Installation of a safety grab rail or reachable support for use when entering or exiting the hot tub is recommended.
 6. A nearby garden hose connection is recommended for filling and "topping up" the hot tub.



WARNING

The hot tub equipment and all electrical plugs, outlets and lights within 1.5m (5ft) of the hot tub must be G.F.C.I protected. Consult your electrician or local electrical authority for further details.

Access to the hot tub must always be secured:

Outdoors - in accordance with local property by-laws and/or via an approved fence with a self-closing gate and a safety hardcover;

Indoors - by a lockable door and a safety hardcover.

SPECIAL CONSIDERATIONS

INDOOR INSTALLATIONS

- It is beneficial to have the hot tub room located near wash room and shower facilities
- The hot tub room should have a floor drain to handle splash water, a window, outside exhaust fan or humidistat controlled exhaust fan for ventilation and a humidifier.
- Consider plumbing a water tap and drain location nearby to facilitate draining and top-up
- Always provide adequate ventilation for the support equipment
- Consult your local Hydropool retailer for further information

OUTDOOR INSTALLATIONS

- Contact your local building code department to determine if a building permit is necessary and for information on applicable bylaws (distance from property lines, buildings, fencing requirements, etc.)
- If you are doing any excavating, contact your local gas, electric, and cable-company to ensure that there are no underground lines
- Locate the hot tub, where practical, within close distance of a door to the house to maximize potential winter use.
- Ensure that all hot tub support equipment is easily accessible and protected from the elements
- The hot tub support equipment is designed for indoor (out of the direct elements) use. When your **HYDROPOOL** hot tub is equipped with a factory-installed cabinet, and installed as per the guidelines of this manual, the equipment will be adequately protected. If the hot tub is shipped without a cabinet, your custom cabinet or other structure must be designed to supply protection for the hot tub support equipment from rain, snow, splash water, etc., but still designed in a manner to ensure adequate ventilation.

SITE PREPARATION

ABOVE-GROUND INSTALLATIONS

Where the hot tub is a “stand-alone” above-ground installation to be installed in regions where freeze/thaw conditions may occur, a level patio stone or pre-formed paver type base may be sufficient if there is no abutting deck(s) that could be damaged during potential seasonal movement of the ground. The potential drawback to this type of base is that splash water could eventually de-stabilize the ground under the base, with the resultant shift of the support base causing damage to the hot tub structure.

For best results, we recommend the installation of a level concrete pad:

- **Dig out and level the ground 20-30 cm (8-12 in.) below your desired base level.**
- **Install 10-15 cm (4-6 in.) of crushed stone.**
- **Next, install 10-15 cm (4-6 in.) of poured concrete.**
- **Level the concrete and apply a broom-type finish.**
- **We recommend that the pad be made 15 cm (6 in.) larger than the hot tub on three sides, and 1 m (3 ft.) larger on the side where the access steps and/or planters will be installed.**
- **Hot tub must be installed on a level pad**

In regions where freeze/thaw occurs, or where there will be custom decking abutting the hot tub we recommend the installation of sono-tubes beneath the pad to prevent shifting.

IN-GROUND & PARTIAL IN-GROUND INSTALLATIONS

For units being installed fully or partially in the ground, the type of support will again vary based on whether or not the tub is being installed in an area with freeze/thaw conditions. Hydropool does **not** recommend back-filling full in-ground or partial in-ground installations.

- Non-freezing climates – it is sufficient to ensure that the base of the hole or cavity created for the tub has a dry, stable, compacted level base and proper drainage.
- Climates where freeze/thaw occurs – it is necessary that a poured level reinforced concrete base, complete with concrete footings, be installed as outlined in the section **ABOVE-GROUND INSTALLATIONS**.

Areas with a high ground water table – a level concrete base, as well as a concrete or wood retaining wall to hold back the earth, is recommended. This forms a box or ‘bunker’, in which the hot tub is placed.

- **ALWAYS** ensure that there is good drainage, via a properly designed French drain (gravel) system and/or a sump pump, to prevent ground water flooding damage to the support equipment or hot tub structure.
- Install protective waterproof conduit to house any cables that will be buried.
- Access for future service must be considered at the time of design and installation. You must be able to access all sides and areas of your hot tub. Difficult access will result in supplemental service labor charges not covered by the factory warranty. Consider easily removable deck materials.
- Make sure the hot tub or swim spa is tested for 48 hours before you prepare the installation of the surrounding/finish deck around your hot tub. Even though all units are tested in our plant, some transport/site handling damage can occur and we suggest you make sure the tub is perfectly waterproof before finalizing your installation.

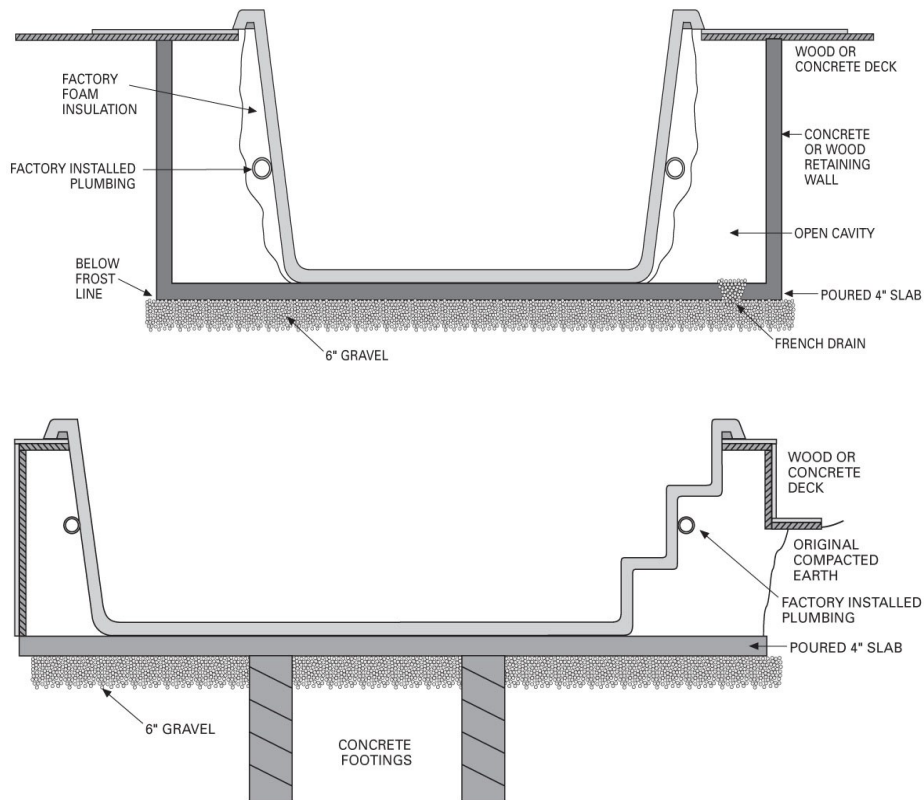

EQUIPMENT ACCESSIBILITY AND PROTECTION

The equipment must be located in an area where it will remain serviceable, dry and will not be exposed to rain, snow or ground water.

UNLOADING / HANDLING YOUR HOT TUB

All HydroPool hot tubs are shipped with a protective combination layer of foam wrap, cardboard and plastic film. Each hot tub is factory strapped onto a wood skid. If your hot tub is to be delivered by your local dealer, it will generally arrive on a flat bed truck or low profile trailer. Most dealers are equipped with the necessary equipment to maneuver the hot tub from the truck to the dolly or cart that will be used to move your hot tub to the installation location.

Should your hot tub arrive in a common closed box trailer, it may be necessary to arrange with a local towing company for a tilt and load tow truck, with a pulley winch system, to pull the skid from the larger trailer to the lower profile tow truck flat bed. The hot tub can be gently slid off the low profile trailer and positioned on its side on a cart or dolly on its back side only.

Most HydroPool models require a clearance width of at least 100 cm. (39 in.) to allow movement of the unit on its side through alley-ways, fence openings, etc. Where this is not possible, the use of a crane to lift the hot tub from the truck or trailer over the house to the patio or yard is often a simple and economical option.



WARNING

- **Do not move or place the hot tub on the side where the equipment is located as damage could occur.**
- **Never roll or flip the hot tub end over end as the cabinet could be damaged.**
- **Never lift or handle the hot tub by the plumbing.**
- **Make sure that there is sufficient assistance to gently slide the hot tub off the dolly or cart to the support base without any damage.**

Important Note: Damage caused during transportation or by improper handling is not covered by the factory warranty.

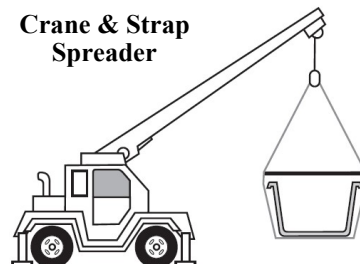
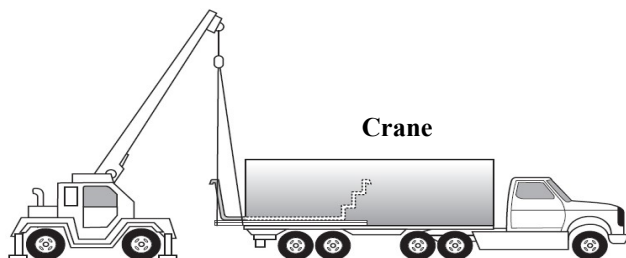

IMPORTANT ELECTRICAL SAFETY INSTRUCTIONS

SAFETY COMES FIRST. WHEN INSTALLING & USING THIS ELECTRICAL EQUIPMENT, BASIC SAFETY PRECAUTIONS MUST ALWAYS BE FOLLOWED!

1. READ AND FOLLOW ALL INSTRUCTIONS

2. Electrical installation must be completed by a qualified electrician in accordance with all National, Regional and Local Codes and Regulations in effect at the time of installation.
3. Connect only to a dedicated circuit protected by a class 'A' two-pole ground fault circuit interrupter (GFCI)
4. **Use copper conductors only!**
5. The hot tub equipment and all electrical plugs, outlets and lights within 1.5m (5ft) of the unit must be G.F.C.I protected. Consult your electrician or local electrical authority for further details.
6. A green colored terminal or a terminal marked "G", "GR", "Ground", or "Grounding" is located inside the supply terminal box or compartment. To reduce the risk of electric shock, this terminal must be connected to the grounding means provided in the electric supply service panel with a continuous copper wire equivalent in size to the circuit conductors supplying the equipment.
7. At least two lugs marked "**BONDING LUGS**" are provided on the external surface or on the inside of the supply terminal box or compartment. To reduce the risk of electric shock, connect the local common bonding grid in the area of the hot tub to these terminals with an insulated or bare copper conductor not smaller than No.6 AWG (Canada/Europe) / No.8 AWG (USA).
8. All field installed metal components such as rails, ladders, drains or other similar hardware within 3 m (10 ft) of the hot tub shall be bonded to the equipment grounding bus with copper conductors not smaller than No.6 AWG.

IMPORTANT NOTE:

- This guide is for standard installations where the wire run is 15 m (50 ft.) or less. For longer wire runs, consult a qualified electrician.

G.F.C.I./R.C.D. APPLICATION GUIDE FOR HYDROPOOL SERENITY SERIES

NORTH AMERICA	
4300 / 4500 / 6600 Models	40A
5900 / 6800 / 6900 Models	50A
EUROPE	
All models	20A

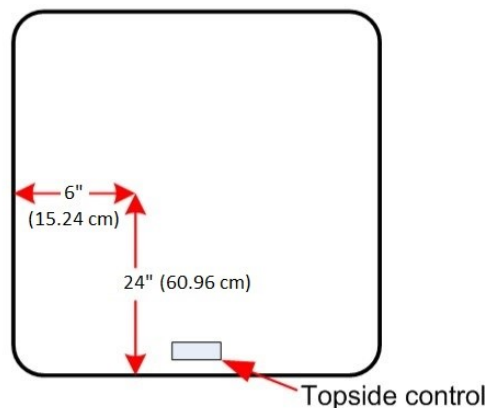

FIGURE 1: ELECTRICAL CONDUIT LOCATION

IMPORTANT NOTE: (FIGURE 1)

The following dimensions can be used to determine the proper location of submerged conduits in concrete slab installations. The dimensions are made from the outside of the spa / hot tub frame with the access for panels removed. The topside control panel is shown at the bottom of the diagram as a reference.

WIRE SIZE

NORTH AMERICA

- The minimum wire size for systems that require a 40A GFCI is # 8/3 c/w ground (also referred to as # 8 gauge / 4 conductor).
- The minimum wire size for systems that require a 50A GFCI is # 8/3 c/w ground (also referred to as # 8 gauge / 4 conductor).

EUROPE

Standards for amperage breakers may vary from country to country in the CE controlled area. Please consult your local installer for advice on breaker level and wire specifications. Some examples are below:

Breaker of 13A –wire must be 1.5 mm²

Breaker of 16A—wire must be 2.5 mm²

Breaker of 20A—wire must be 4.0 mm²

Breaker of 32A—wire must be 6.0 mm²

NOTE: Please consult your applicable electrical codes related to the size of conductors as they may vary from what is stated above. Take into consideration the length of cable as well and increase as required.

NORTH AMERICA – GFCI INSTALLATION



NOTICE

Installation of the GFCI - Circuit Breaker, including ampere sizing and selection of conductor size and type, must be performed by a qualified electrician in accordance with the National Electrical Code, or the Canadian Electrical Code, and all Federal, State/Provincial and local codes and regulations in effect at the time of installation. HydroPool highly recommends the use of a new Siemens GFCI breaker for all of its products. Other GFCI's and older Siemens GFCI's may have tripping issues.

SIEMENS - 240 VOLT TYPICAL

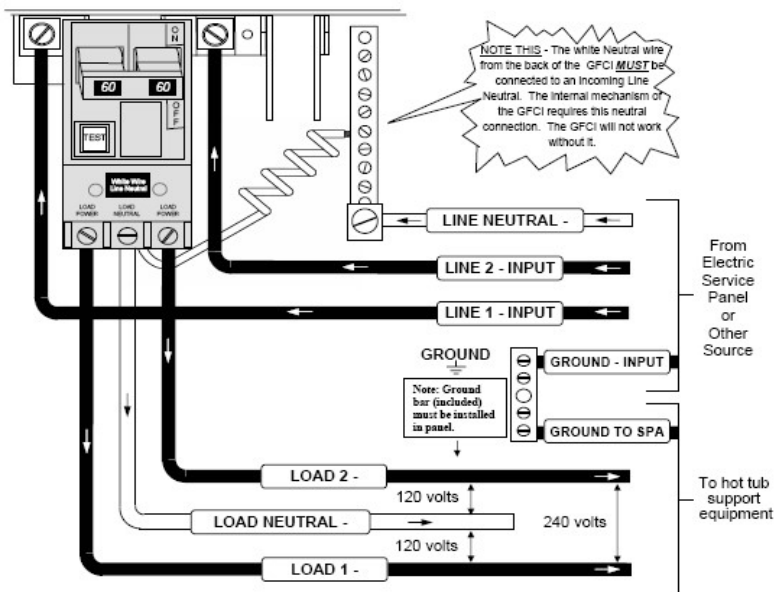

EUROPE – R.C.D. INSTALLATION - TYPICAL



NOTICE

Important Note: Installation of the R.C.D. - Circuit Breaker, including ampere sizing and selection of conductor size and type, must be performed by a qualified electrician in accordance with National, Regional and Local Codes and Regulations in effect at the time of installation.

230 VOLT 50 Hz SINGLE PHASE RCD WIRING

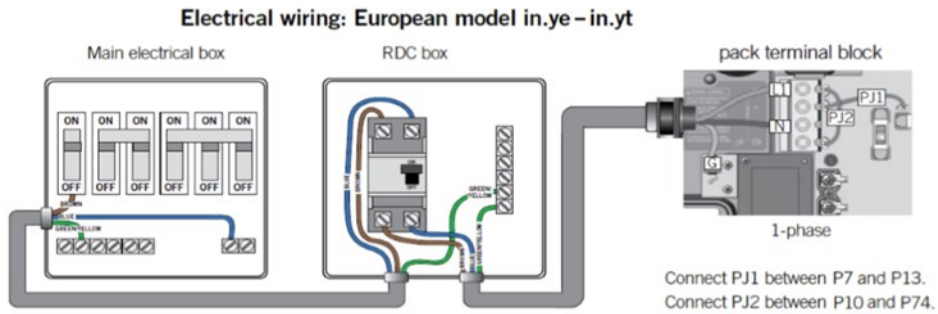

230 VOLT 50 Hz DUAL PHASE RCD WIRING

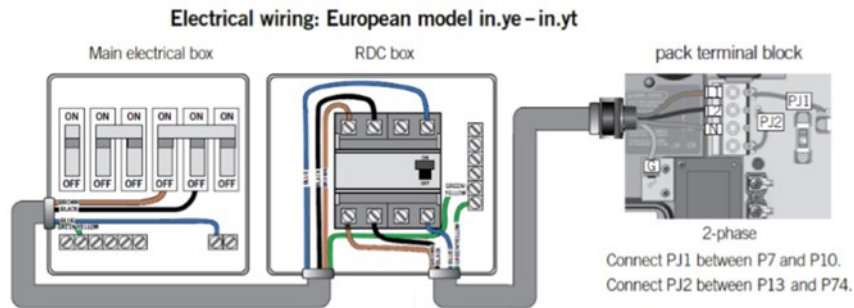

230 VOLT 50 Hz THREE PHASE RCD WIRING

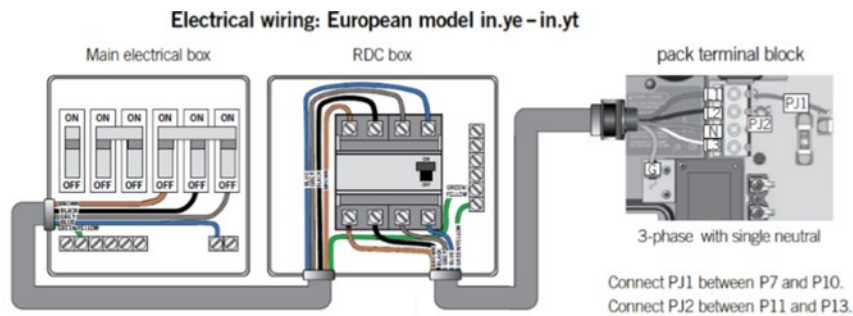

FILLING, CHECKING AND STARTING YOUR HOT TUB

GATE VALVE

UNIONS

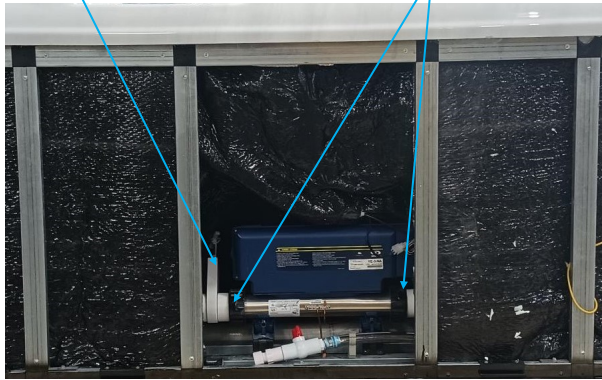

FILLING

- When adding water for the first time, the hot tub should be filled through the skimmer opening (helps to prevent air locks) using a standard garden hose, turning the tap on slowly to prevent damage to the surface by a jerking hose connection.
- Ensure the handles on the intake and return gate valves are pulled up and stem locks are in place.
- Ensure the drain hose-bib is closed.
- Ensure that all jets are open.
- Fill the hot tub to the recommended level, approximately 4 inches above the top of the skimmer opening.

CHECKING

- Although your hot tub was thoroughly water-tested in the factory, some loosening of fittings can occur during shipping. Before any decking, tiling or carpeting is completed around the installation, fill and operate your hot tub to test for leaks (this ensures easy access and inexpensive correction). Check all union connections and plumbing for minor leaks. In the event of a leak, ensure all union connections and pump plugs are tight and all o-rings/gaskets are in place.

STARTING

- Before applying voltage to power-up your hot tub, it is very important that you understand the sequence of events that occur when the system is activated in order that the pump can be primed efficiently and damage to the system can be avoided.
- Turn the main power “on” at your electrical panel.
- Follow the control instructions for your particular model hot tub to put the pump into low speed **see section HYDROPOOL CONTROL SYSTEMS PUMP PRIMING/RELEASING AN AIR LOCK**
- On some systems a message will appear on the display indicating that the system is in PUMP PRIMING MODE (“**RUN PMPS PURG AIR**”). This mode will last for 4 minutes before automatically entering the normal operation mode. **See complete details for your spa in section HYDROPOOL CONTROL SYSTEMS**

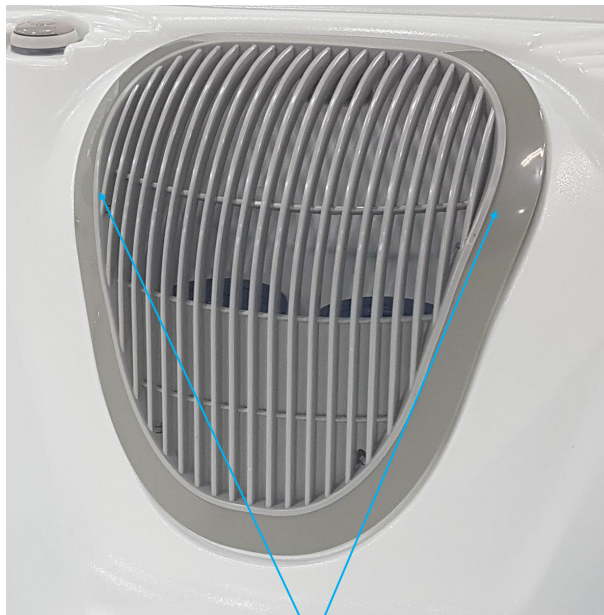

**PROPER WATER LEVEL AT
SKIMMER OPENING**

O- RING / GASKET AT UNION CONNECTIONS

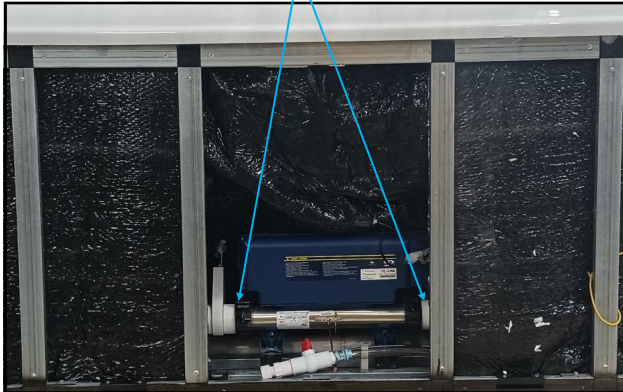

RELEASING AN AIR LOCK...

...THROUGH THE PUMP UNION



- The water should start circulating immediately. If the motor works **but if you** do not notice water circulation within the first 15 seconds, the pump may require priming due to trapped air (referred to as an 'air lock'). If the pumps have not self-primed after 2 minutes, and water is not flowing from the jets, **DO NOT** allow the pumps to continue to run. Turn power off at the main house panel (or GFCI) and try releasing the air by loosening the union on the discharge side of the pump(s) while the motor is not running. Turn the power back on. If the pumps do not prime after 15 seconds, sometimes momentarily turning the pump(s) off and on will help the system to prime (note: do not do this more than 5 times). **Repeat if necessary.**

- Important: Under **NO** circumstances should the pump(s) be allowed to operate without priming beyond 5 minutes, as this may not only cause unwarrantable damage to the pump, it may also cause the control system to go into an overheat condition.
- Turn the hydrotherapy pump(s) onto high speed and re-check for leaks. The control system will automatically return the pump to low speed after 15 minutes.
- Adjust the hot tub heat control at the topside panel to the desired water temperature.
- Adjust water balance (pH, TA, calcium hardness) to recommended levels and add sanitizer once the water temperature reaches 20°C (68°F).
See section HOT TUB WATER BALANCE
- Keep insulated safety hard cover on the hot tub, and the air controls closed during the entire heat up process.

NOTE:

In order to prevent damage to your pillows caused by the gassing effect of the chemicals, we do recommend to remove them when the spa is not in use. By removing them you will extend considerably the life length of your pillows. We do design ours pillows to be removed easily in order to make sure they will not remain in the spa when it's not in use.

HYDROPOOL SERENITY SERIES CONTROL SYSTEMS NORTH AMERICA/ EUROPE GECKO IN.YE3



INITIAL START-UP

Before applying voltage to power-up your hot tub, it is very important that you understand the sequence of events that occur when the system is activated in order that the pump(s) can be primed efficiently and damage to the system can be avoided.

PROGRAM MENU

The program menu is accessible by holding down the Light Key for 5 seconds. In the Program Menu the following parameters can be set: clock, filter or purge cycles, economy mode and temperature units. While in the program menu, use the Up and Down keys (Up/ Down Key) to adjust the parameters and the Light key to jump to the next parameter. The changes will be saved after the confirmation of the last parameter only. If there is no action taken for 10 seconds, the system will exit the program menu without saving any changes.

SETTING THE CLOCK TIME

Enter the program menu by holding down the Light Key for 5 seconds. The display will show the current clock setting with the hour flashing. Use the arrow keys to adjust the hour. Press the Light Key to adjust the minutes. Press the light key to jump to the next parameter or to the end of the parameters to save the time.



**TEMPERATURE CONTROL
FUNCTIONALITY AND
ADJUSTMENT**



After you exit the programming mode your hot tub will automatically heat to the factory preset default temperature of 38°C (100°F).

The temperature shown on the screen is the current water temperature. Use the UP and DOWN buttons to set the desired temperature.

The set point icon will appear at the top of the screen. After 3 seconds without any change to the set temperature value, the keypad will resume the normal display.

STANDBY MODE

Pressing the JET key for 5 seconds will enable the Standby Mode. This mode allows you to stop all outputs including automatic functions such as the filter cycle, heat request and smart winter mode for 30 minutes to perform quick spa maintenance. When active, the display will toggle between the "OFF" message, the clock and water temperature.



HYDROPOOL SERENITY SERIES CONTROL SYSTEMS

NORTH AMERICA / EUROPE

4300 / 4500 / 6600 / SE45L MODELS

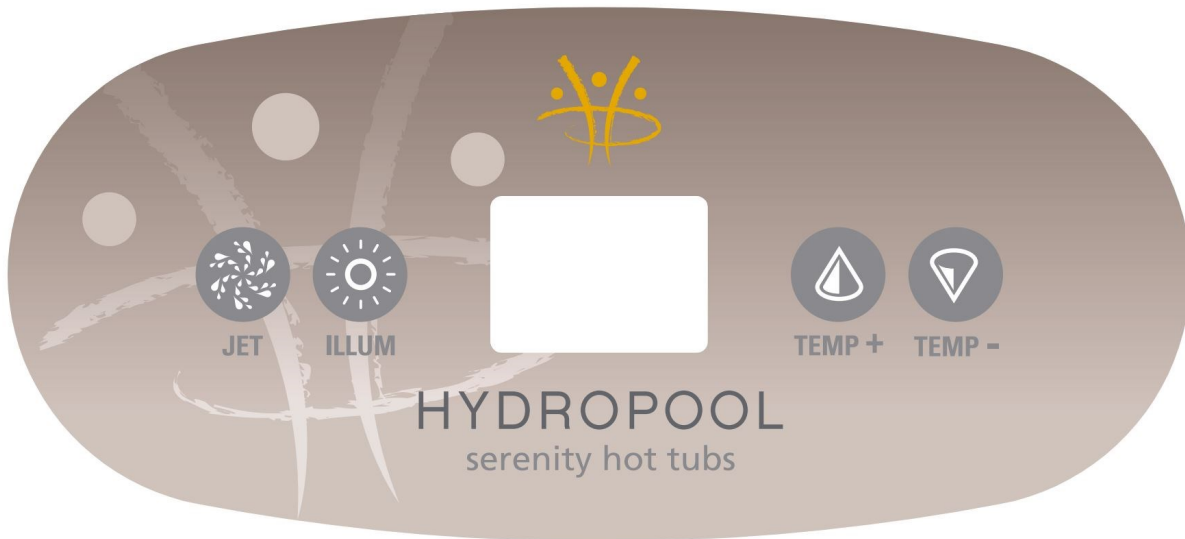

KEYPAD FUNCTIONS AND DISPLAY ICONS

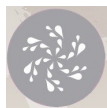

JET KEY WHICH CONTROLS PUMP 1



ILLUM KEY WHICH CONTROLS THE LIGHTING AND THE PROGRAMMING

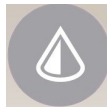

TEMPERATURE UP KEY

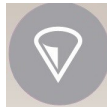

TEMPERATURE DOWN KEY

HYDROPOOL SERENITY SERIES CONTROL SYSTEMS

NORTH AMERICA / EUROPE

5900 / 6800 / 6900 MODELS



KEYPAD FUNCTIONS AND DISPLAY ICONS



JET KEY WHICH CONTROLS PUMP 1

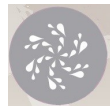

JET KEY WHICH CONTROLS PUMP 2

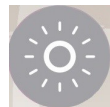

ILLUM KEY WHICH CONTROLS THE LIGHTING AND THE PROGRAMMING



TEMPERATURE UP / DOWN KEY

HYDROPOOL SERENITY SERIES CONTROL SYSTEMS GECKO IN.YE3 NORTH AMERICA / EUROPE

PROGRAMMING THE FILTER / PURGE CYCLES

The filter cycle menu consists of the following parameter: the start time (FS), the duration (Fd), and the frequency (FF).

NOTE: A filter cycle consists of starting all the pumps and blower (if equipped) in high speed for 1 minute (purge step) then the pump associated with the filter cycle will run in low speed for the remaining duration of the filter cycle (clean up step).

SETTING THE FILTER CYCLE

After you have programmed the clock, the next parameter is the filter cycle start time. The display will show FSxx, with “xx” representing the starting hour of the cycle. Use the arrow keys to adjust the hours. Use the Light Key to jump to the next parameter, filter duration (Fd).

The display will show Fdxx, with “xx” representing the duration in hours of the filter cycle. Use the arrow keys to adjust the duration. Use the Light Key to jump to the next parameter, filter frequency (FF).

The display will show FFxx, with “xx” representing the number of cycles per day. Use the arrow keys to adjust the frequency. Use the Light Key to jump to the next parameter, economy mode (EP)

This mode allows you to lower the temperature set point of the spa by 20F (11C) during a certain period of the day.

The display will show Epx, with “x” representing the state of the programming (0 = disabled, 1 = enabled). Use the arrow keys to enable or disable the economy mode. Use the light key to jump to the next parameter, economy start time (ES).

When the Economy mode in ON, the display will toggle between the “Eco” message, the time and the water temperature.

The display will show ESxx, with “xx” representing the hour at which the economy mode will become active. Use the arrow keys to adjust the hour. Use the Light Key to jump to the next parameter, economy duration (Ed).

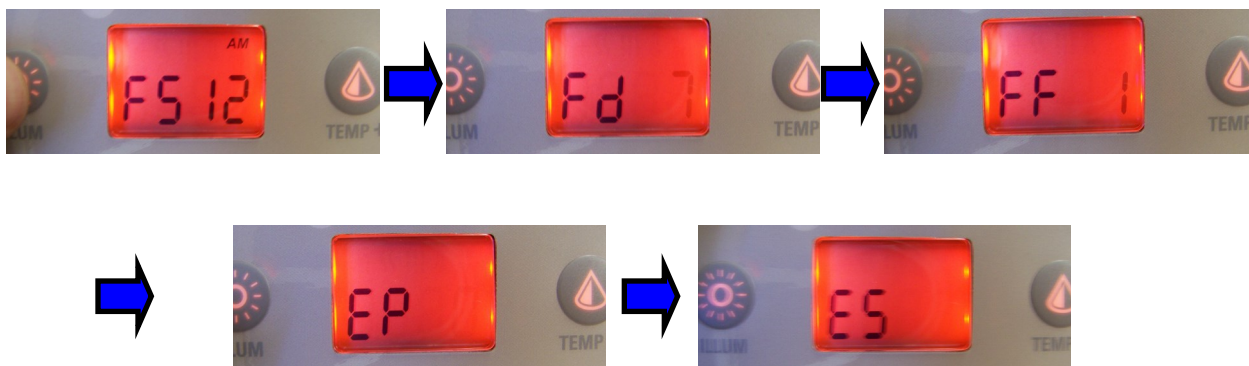

HYDROPOOL SERENITY SERIES CONTROL SYSTEMS GECKO IN.YE3 NORTH AMERICA / EUROPE

The display will show Edxx, with “xx” representing the duration in hours of the economy mode. Use the arrow keys to adjust the hour. Use the Light Key to jump to the next parameter, temperature unit.

Water temperature can be displayed in either Fahrenheit (°F) or Celsius (°C). The display will show °F or °C. Use the arrow keys to change the setting. Use the Light Key to save all the parameters.

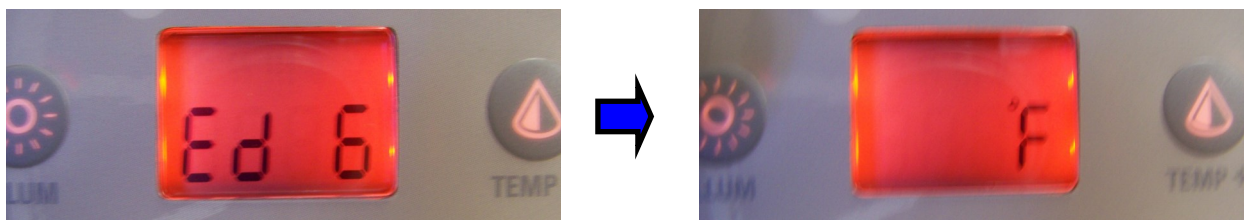

SMART WINTER MODE

Smart Winter Mode protects your system from the cold by turning the pumps on several times a day to prevent water from freezing in the pipes. The Smart Winter Mode indicator turns on when in this mode of operation. If the temperature drops to 4°C (39°F) within the heater chamber, the system automatically activates the pump to provide freeze protection. The pump will operate until the temperature reaches 5°C (41°F) before returning to normal system mode.

COOLING DOWN

After heating the spa water to the desired set point, the heater is turned off, but the filtration pump remains on for a certain amount of time to ensure adequate cooling of the heating element in order to prolong the useful life of the heater. The heater icon flashes during this time.

PUMP 1 FUNCTION



Press this key (JET or JET 1) to activate the pump

- 1st press – low speed (**indicator light flashes**)
- 2nd press – high speed (**indicator light on solid**)
- 3rd press – turns off (**indicator light off**)

PUMPS AUTOMATIC TIME-OUT

Time out – 15 minutes

PUMP 2 FUNCTION



Press this key (JET 2) to activate the pump

- 1st press – high speed (**indicator light on solid**)
- 2nd press – turns off (**indicator light off**)

PUMPS AUTOMATIC TIME-OUT

Time out – 15 minutes



LIGHT FUNCTION

Press this pad to activate the light

- 1st press: rotating colours
- 2nd press: solid blue colour
- 3rd press: solid green colour
- 4th press: solid red colour

Note: Pressing the light key in intervals less than five seconds will scroll to the next colour. Once you have selected the colour another press will turn the light off.

LIGHT AUTOMATIC TIME-OUT

Time out – 60 minutes

TOPSIDE PANEL DISPLAY MESSAGES

- Hr:** An internal hardware error has been detected.
- HL:** The system has shut down the heater because the temperature at the heater has reached 119°F (48°C),
- AOH:** Temperature inside the spa cabinet is too high causing the internal control temperature to increase above normal limits.
- FLO:** The system does not detect any water flow while the primary pump is running.
- Prr:** A problem is detected with the temperature probe.
- OH:** The water temperature in the spa has reached 108°F (42°C)

OPTIONAL VARIABLE AIR THERAPY SYSTEM CONTROL FUNCTIONS

Press: Blower button on main control to activate system.

1) ON/OFF :

- 1st Press:** The Blower starts at maximum Speed. LED: ON
- 2nd Press:** The blower stops. LED: OFF

2) TO CONTROL SPEED:

Press and hold: Speed goes up or down, LED: ON when pressing. Release pressure at the desired speed.

3) TO CONTROL PULSATION:

- 1st Press:** Slow Pulsation Cycle, LED: ON.
- 2nd Press:** Quick Pulsation Cycle, LED: Flashes.
- 3rd Press:** Pulsation Cycle OFF, LED: OFF.



OPTIONAL HYDROCLEAR PUREWATER SYSTEM

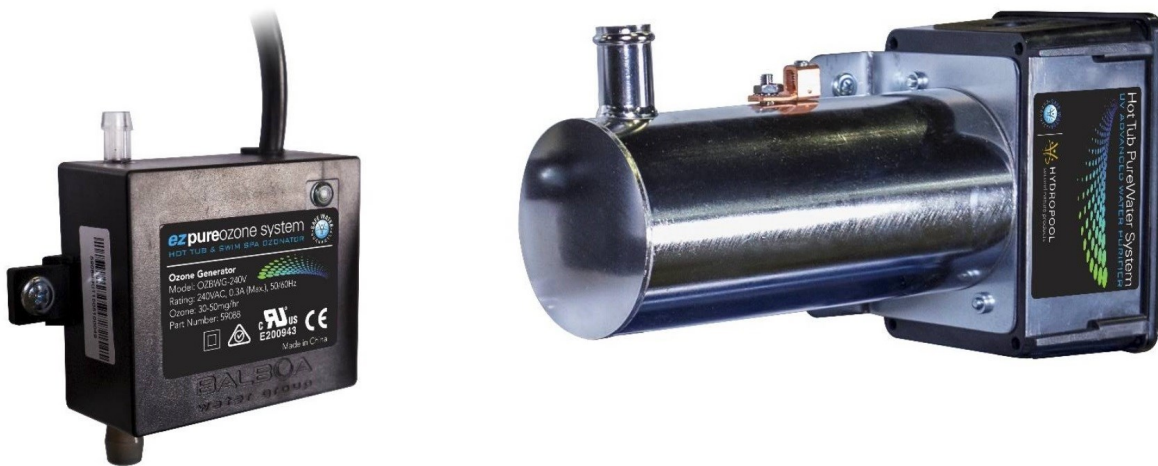

HOW IT WORKS

This system combines the benefits of both Ozone and UV-C creates hydroxyl radicals to burn off contaminants and dissolved solids within the water to significantly increase the clarity of the spa water. The UV-C rays also breakdown chloramines which are the main cause of respiratory, eye and skin irritation typically associated with chlorine. Harmful/corrosive off gassing is also dramatically reduced through this process.

MAINTENANCE AND SERVICE

While operating, check regularly to see if bubbles are entering the spa.

After 10,000 hours the UV LED will begin flashing yellow indicating its time to replace the UV-C lamp.

Replace the check valve assembly annually to ensure continued optimal performance from the Hydroclear Pure Water System.

To replace the UV-C lamp or check valve please go to www.balboawatergroup.com/UVSanitizers for the procedure on how to do this.

IMPORTANT

YOU MUST CONTINUE TO CHECK YOUR WATER CHEMISTRY REGULARLY AND SANITIZING CHEMICALS WILL BE NECESSARY TO TREAT THE WATER. CONSULT YOUR SPA PROFESSIONAL FOR FURTHER ADVICE.

OPTIONAL HYDROCLEAR PUREWATER SYSTEM (continued)

UV-C LAMP REPLACEMENT INSTRUCTIONS

Important: It is mandatory that the UV-C lamp is replaced every 12 months to maintain optimum performance.

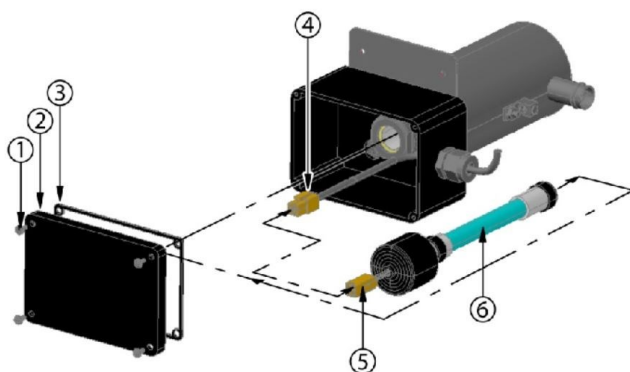

KEY	DESCRIPTION
1	SCREW
2	ENCLOSURE COVER
3	ENCLOSURE GASKET
4	BALLAST CONNECTOR
5	UV-C LAMP CONNECTOR
6	UV-C LAMP

NOTE: Your UV System unit may look different than shown in the picture



DANGER

- Turn the spa breaker to the OFF position.
- Allow the UV-C lamp (6) to cool down prior to removing it from the UV system.
- Never look at the lit UV-C lamp (6). This can cause severe eye damage or blindness.

INSTRUCTIONS:

1. Remove the UV system enclosure cover (2) by removing 4 Phillips screws (1). Keep the gasket (3) together with the enclosure cover (2) for later use.
2. Make sure to use latex glove when handling the UV-C lamp (6).
3. Slowly disconnect the old UV-C lamp connector (5) from the ballast connector (4).
4. Slowly remove the old UV-C lamp (6) from the UV unit.
5. Slide the new UV-C lamp (6) into the UV unit.
6. Reconnect the new UV-C lamp connector (5) to the ballast connector (4). Make sure the connectors mate completely. Do not force.
7. Reinstall the enclosure cover (2) with the gasket (3) and secure with screws (1).
8. Reconnect the unit to the spa controller and reinstall the spa controller's cover.
9. Turn on the power to the spa.
10. Once power is activated you can check the ballast to see if the unit is functioning. A solid green light indicates the unit is being provided power and should always be on. A solid red light indicates that the UV-C lamp is activated.



WARNING

The UV-C lamp used in this unit contains mercury. Properly dispose of the old UV-C lamp in accordance with disposal laws. See www.lamprecycle.org.

HOT TUB WATER BALANCE – GENERAL OVERVIEW

NOTABLE POINTS

- The reliability and longevity of your hot tub support equipment are directly related to how well water quality is maintained!
- The small volume of water in your hot tub is easily affected by the introduction of oils, lotions, perspiration and chemicals. It is imperative that you give your hot tub regular attention to maintain clean, and balanced water to prevent premature damage and/or failure (corrosion/calcification) to the support equipment. Maintaining proper hot tub water balance and sanitizer levels is extremely important. Neglected hot water will allow bacteria to quickly spread.
- The mineral content of hot tub water increases due to water evaporation, sanitizers and other chemicals. If the mineral concentration, particularly calcium, becomes too high, the minerals will literally “drop” or precipitate out of the water and deposit on the hot tub walls, plumbing, jets, in the filter and on the heater element.
- It is very important that pH be checked frequently and maintained in the recommended range as indicated in the chart **WATER BALANCE SUMMARY FOR YOUR HOT TUB**
- It is also very important that Total Alkalinity (the ability of the water to resist a change in pH) be maintained in the recommended range as indicated in the chart **WATER BALANCE SUMMARY FOR YOUR HOT TUB**
- Although there may be two identical hot tub models right next door to each other, the maintenance requirements will be different, dependant on such factors as:
 - bather load
 - frequency of use/quantity of bathers
 - different body chemistry
 - sun vs. shade
 - temperature

For these reasons, it is very important to develop proper hot tub water maintenance habits and follow your HydroPool retailer’s recommended water maintenance procedures.



Heater and other component failure due to improper water balance is not covered under warranty.



WARNING

CHEMICAL HANDLING SAFETY HINTS

- Never pre-mix chemicals with each other prior to adding to hot tub water.
- Add only one chemical to the water at a time.
- Always add chemicals to water and not vice-versa.
- Chemicals may be corrosive, so handle with care and store in a cool dark place.
- Never smoke near chemicals as most are flammable
- Ensure any spilled chemicals are carefully cleaned up immediately.
- Always have the POISON CONTROL telephone number handy in the event of an emergency.
- Keep chemicals out of children's reach
- Wear safety glasses and gloves when handling chemicals.

INITIAL WATER FILL AND BALANCE

1. Make sure the hot tub water is circulating and above 20°C (68°F)
2. Add a sequesterant (stain and scale controller). Allow water to circulate for an hour before adding anything else to the hot tub water.
3. Add a Shock / oxidizing agent .
4. Add sanitizing tablets (Bromine or Chlorine) to the dispenser:

Built in dispenser: if your HydroPool hot tub was ordered with the optional built in bromine/chlorine dispenser, (located under the basket of the cartridge filter housing), **refer to section CARTRIDGE FILTER for details on removing and re-installing the lid.** Once the filter lid is removed, you'll notice a clear 2.5 cm (1 in.) tube extending from the bottom of the basket. Expose the large Refill hole at the end of the tube and add 5 or 6 tablets. Do not overfill dispenser as performance will be affected. Turn to expose the most number of smaller holes and allow water to circulate for 3 to 4 hours before testing level. Adjust to lesser number of holes as necessary to maintain a level of 2-4 PPM Sanitizer.

Floating dispenser: As above, add 6 or 7 tablets, adjust initially to '5', allow water to circulate for 3 to 4 hours, then test. The tablets will dissolve slowly over a 10-14 day period, depending on dial setting, and use of the hot tub.

5. Test pH and Total Alkalinity and adjust accordingly.

GLOSSARY OF COMMON WATER MAINTENANCE TERMS

1. **CHLORINE** – in granular, liquid or puck/tablet form, is an oxidant and biocidal agent. It is very effective and fast acting. Recommended chlorine residual level is 3.0 to 5.0 ppm.
2. **CHLORAMINES** – a compound formed when chlorine combines with nitrogen or ammonia present in the water. When allowed to go unchecked, it causes eye and skin irritation and is indicated by a strong chlorine odor.
3. **ONE-PART BROMINE** – also available in puck/tablet form, is another type of oxidant/biocidal agent, and is introduced into the hot tub water via a brominator. Recommended bromine residual level is 3.0 to 5.0 ppm
4. **TWO-PART BROMINE** – composed of a liquid or powder component introduced manually into the water on a weekly basis, and a granular component that is added daily or as the hot tub is used.
5. **BROMAMINES** – are formed when bromine destroys nitrogen-bearing organic matter. Unlike chloramines, bromamines don't cause eye irritation, however, when allowed to go unchecked, will cause an objectionable odour.
6. **SHOCK** – the practice of adding an oxidizing agent to hot tub water to destroy ammonia, nitrogenous and organic contaminants (chloramines and bromamines)
7. **pH** – a logarithmic value expressing the relative acidity or basicity of a substance (such as hot tub water) as indicated by the hydrogen ion concentration. pH is expressed as a number on a scale of 0 to 14, where 0 is most acidic, 1 to 7 being acidic, 7 considered neutral, 7 to 14 being basic, and 14 being most basic. The ideal range for hot tub water is 7.4 to 7.6 ppm
8. **pH INCREASER** – raises the pH level of the water.
9. **pH DECREASER** – lowers the pH level of the water.
10. **TOTAL ALKALINITY (TA)** – the amount of carbonate, bicarbonate and hydroxide compounds present in the water that determines the ability or capacity of the water to resist change in pH. Also known as the 'buffering' capacity.
11. **ALKALINITY BOOSTER** – raises the alkalinity.
12. **CALCIUM HARDNESS** – the calcium portion of the total alkalinity which represents 70 to 75% of total hardness. Calcium concentrations determine whether water is 'soft' - too little calcium, or 'hard' -too much calcium.
13. **CALCIUM BOOSTER** – increases the calcium level.
14. **TOTAL DISSOLVED SOLIDS (TDS)** – a measure of the total amount of dissolved matter in the water (calcium, carbonates, bicarbonates, magnesium, metallic compounds, etc.)
15. **SEQUESTERANTS (STAIN AND SCALE CONTROLLERS)** – keeps dissolved metals and minerals in the water from attacking the hot tub shell and support equipment components.
16. **DEFOAMER** – removes foam build-up from the water surface. At best, this is a temporary remedy, as excessive foam is merely a symptom of improper water balance (typically high organic residue and/or high pH).
17. **CARTRIDGE FILTER CLEANER** – degreases and cleans cartridge filters.
18. **OZONATOR** – generates Ozone (a gaseous molecule composed of 3 atoms of oxygen) and is injected into the hot tub water for the oxidation of water contaminants.
19. **TEST KIT** – used to monitor specific chemical residual or demands in the water. May be in the form of litmus strips or liquid drops.
20. **PPM** – abbreviation for 'parts per million', the unit of measurement used in chemical testing which indicates the parts by weight in relation to one million parts by weight of water. Essentially identical to the term mg/L - milligrams per liter.

WATER BALANCE SUMMARY FOR YOUR HOT TUB*

SANITIZER (ppm)	MIN	IDEAL	MAX
Chlorine	1.0	3.0 – 5.0	5.0
Bromine	1.0	3.0 – 5.0	5.0
CHEMICAL			
PH	7.2	7.4 – 7.6	7.8
Total Alkalinity (TA)	80	80 – 120	180
Calcium Hardness	150	200 – 400	500 – 1000

*National Spa and Pool Institute recommended levels for residential spas / hot tubs.

WATER BALANCE TROUBLESHOOTING

PROBLEM	POSSIBLE CAUSES	SOLUTIONS
Cloudy Water	Microscopic particles too small to filter out.	Test and adjust all water balance elements and add flocculent* to cause the particles to combine together so they can be filtered out. Increase filter cycle time.
High Total Alkalinity High pH levels High Calcium Hardness		Test these water balance elements and adjust to recommended parameters.
Scale (White/Grayish Deposit)	High Calcium Hardness	Test calcium hardness level and treat with sequestering agent* or perform partial drain/refill.
Skin Eye Irritation	Improper pH and/or Total Alkalinity levels	Test water balance and make the appropriate changes.
Excessive Foam	Buildup of body oils or cosmetics	If no water line is present you can try using defoamer* to break up the contaminants and then a clarifier* to help filter them away. If a water line is present the spa may need to be drained and cleaned. Either way, the filter should be thoroughly cleaned by soaking overnight in bleach. An oil absorbing sponge can help in preventing this in the future. Increase filter cycle time.

WATER BALANCE TROUBLESHOOTING (continued)

PROBLEM	POSSIBLE CAUSES	SOLUTIONS
	Laundry detergent residual in swimwear	Prevent by running an extra rinse cycle on washing machine or re-rinse well by hand
	Excess organic contaminants	Some organic matter is prone to causing foamy water as it breaks down in the filter (maple leaves especially). Generally using defoamer* to break up the contaminants, then a clarifier* To help filter them away followed by thoroughly cleaning your filter will clear up the problem. It may however be necessary to drain and refill your spa if the foaming is quite excessive.
	Low Calcium Hardness	Test calcium hardness and if necessary increase with calcium chloride*
Corrosion/Etching	Presence of metals in water (iron, copper, etc)	Test total alkalinity levels and if necessary increase with sodium bicarbonate*
Discoloured Water (Clear v. turbid water)	Presence of metals in water (iron, copper, etc)	Treat with chelating* or sequestering agent*
Unstable pH	Low Total Alkalinity levels	Test total alkalinity levels and if necessary increase with sodium bicarbonate*
pH resistant to changing	High Total Alkalinity levels	Test total alkalinity levels and if necessary decrease with sodium bisulfate* or muriatic acid*
		* Contact your local Hydropool retailer for specific product recommendation

ROUTINE HOT TUB MAINTENANCE



REVIEW CHEMICAL HANDLING SAFETY HINTS

DAILY

1. Test water, and if necessary, add shock.
2. Ensure proper water level is maintained.

WEEKLY

1. Test pH and Alkalinity. Adjust accordingly
2. Top-up chemical dispenser
3. Add sequesterant (**stain and scale controller**)
4. Remove and spray cartridge filter with garden hose and re-install (**see section CARTRIDGE FILTER**)
5. Add Shock / oxidizing agent
6. Inspect union connections for o-ring and gasket leaks - Tighten if loose.
7. Clean stainless steel components that are above the waterline.

MONTHLY

Soak your filter cartridge in a filter cartridge cleaning solution. Rinse thoroughly and, if possible, allow to dry before re-installing. HydroPool recommends purchasing a second filter so that while the first is cleaning, the other is clean and ready to install.

QUARTERLY

Drain hot tub at least once per quarter and clean the acrylic shell surface with a non-abrasive cleaner designed specifically for acrylic surfaces. **See sections CHANGING THE HOT TUB WATER and DRAINING YOUR HOT TUB**

NOTE:

HYDROPOOL reserves the right to void the warranty of your spa if there is any indication of the use of products containing Hydrogen Peroxide.

CARTRIDGE FILTER

The cartridge should be cleaned every two to four weeks, depending on the amount of use.

Signs that the filter requires cleaning include:

- **Reduced jet power**
- **Hazy gray water**
- **Rattling noise in the pump or filter**
- **Heater not working**

REMOVAL

1. Activate the **HOLD/STANDBY** mode.
2. Remove the filter cover and place to the side.
3. Rotate the locking flange counter clockwise to disengage.
4. Pull the filter lid upwards, and lift the cartridge element straight up and out of filter housing.

CLEANING

5. With a garden hose and spray nozzle, hose off the cartridge element, ensuring to carefully separate every pleat.
6. To remove collected lotions, body oils, etc. soak the cartridge in warm water and a filter cleaning/emulsifying compound (**available at your HYDROPOOL retailer**).
7. A cleaning cylinder may be purchased from your **HYDROPOOL** Hot tub Retailer.
8. Rinse thoroughly and dry before replacing.
9. Hydropool recommends purchasing a spare filter cartridge so that you always have a clean substitute ready to rotate.
10. After the element has dried - if necessary, lightly brush between pleats with a fine paint-brush to remove remaining dirt particles.



**Do not use a wire brush or other devise to clean cartridge element.
Do not put in dishwasher or washing machine**

RE-INSTALLATION

11. Place the cartridge filter back into the filter housing.
12. Rotate the flange clockwise until it locks in place.

CHANGING THE HOT TUB WATER

A hot tub should be drained every 8-12 weeks, depending on size and amount of use. If your hot tub is used daily or by a large number of bathers, the water should be drained more often. One method to determine the approximate length of time between water changes is to divide the water volume (in liters) of your hot tub by 13.5 and then divide by the average number of bathers each day.

Formula $\left(\frac{\text{Volume of water}}{13.5} \right) \div (\text{Average daily bathers}) = \text{Days between water change}$

EXAMPLE:

1000 liters divided by 13.5 divided by 2 = 37 days.

The hot tub water must be changed when the amount of dissolved solids become excessive, and is usually indicated by “gray” or dull looking water.

WATER SOFTENERS

Never fill a hot tub with water from a water softener, as it could adversely affect the water chemistry, making it difficult to maintain proper water balance. If you live in an area with hard or soft water, give careful attention to your Calcium Hardness level. Topping Up with soft water is acceptable.

EACH TIME BEFORE FILLING THE SPA

1. Check to be sure that the drain shut off valve is closed (turn handle clockwise until it stops)
2. Check that the safety cap is securely in place.
3. If the drain valve is facing a wall, leave enough space between the valve and wall (6” minimum) in order to have enough space to connect a garden hose.

TO DRAIN THE SPA

1. Turn Power Off

Turn the power off at the spa consoles and deactivate disconnect switches at the GFCI plug or load center.

2. Locate Spa Drain Valve

The spa drain valve is located in the equipment area behind the front panel

3. Remove Drain Valve Safety Cap

Pull the drain valve completely out. Remove the safety drain cap and store for use when refilling your spa. Attach a standard garden hose to the drain valve.

4. Attach Hose & Drain

With the garden hose attached rotate the ball valve to begin the draining process. To stop draining the tub close the ball valve.

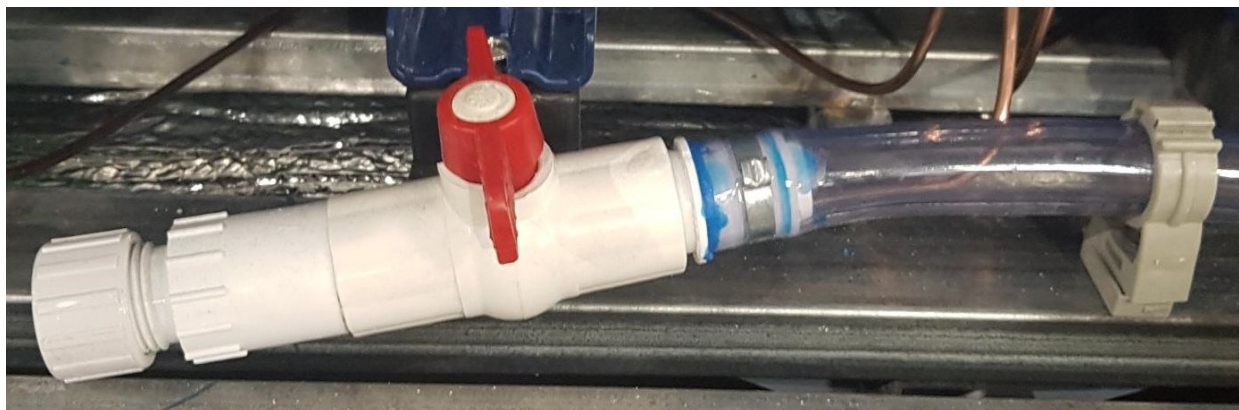

SERENITY FILTER GRILL AND LEAF BAG

On the back of each Serenity filter grill is a leaf bag that is utilized to catch any surface debris and to extend the life of the filter cartridge. The leaf bag is attached the back of the grill with clips that are screwed into the grill and the loop holes on the leaf bag slip onto each hook on the clips.

In order to clean the leaf bag of any dirt or debris you need to unclip it from the back of the grill and clean it accordingly removing all of the dirt and debris. You may want to give it a thorough rinse with a garden hose to ensure it is completely clean.

Simply clip the leaf bag back into position taking note of the clip positions and how things line up.

Once you are done you can easily reinstall the filter grill back into the hot tub.





CLEANING THE ACRYLIC SURFACE

The acrylic surface can be cleaned and polished using a soft cloth and acrylic cleaner, available at your HydroPool Retailer.

- **Important: Do not use detergents - the remaining residues will adversely affect water chemistry, making it difficult to maintain proper water balance**
- **Do not use abrasive cleaners - damage to the acrylic surface will occur.**

SAFETY HARD COVER

When a hot tub is uncovered, over 90% of heat is lost from the water surface. This evaporation also affects the chemical balance and could create humidity problems indoors. **HYDROPOOL** Safety Hard Covers are engineered for maximum thermal efficiency and appearance. They are hinged in the middle for easier handling, and the zip fastener allows the tapered foam inserts to be changed if damaged. The skirt of the safety hard cover overlaps the lip of the hot tub for a finished fit. The locks, with one part fastened to the deck or skirt, prevent small children or animals from entering the hot tub. Do not drag the safety hard cover across the hot tub or decking. Standing on the hardcover could cause the tapered foam inserts to crack, which will lead to water absorption.

NEVER LEAN OR STAND ON YOUR HARDCOVER.

The cover should be cleaned at least twice a year with a vinyl moisturizer and protector.

NOTE: ALWAYS ENSURE THE SAFETY HARDCOVER IS IN PLACE AND LOCKED WHENEVER THE HOT TUB IS NOT BEING USED. FAILURE TO DO SO MAY CAUSE DAMAGE OR CRACKING OF THE ACRYLIC SURFACE NOT COVERED UNDER THE WARRANTY.



PROTECTING YOUR CABINET FINISH

Some **HYDROPOOL** hot tub cabinets are made from Dura synthetic plastic material. These cabinets utilize a magnetic latching system to fasten and hold the exterior panels in place. In order to remove a panel for access you need to start at the lower right hand corner of the panel and disengage the first magnetic latch by pulling the panel forward enough to allow your hand to get behind the panel. Once you have done that you can run your hand behind the panel to disengage the other magnetic latches and be able to remove the panel completely.

To reinstall the panel, line the panel up in the opening and lift it in place and the magnetic latches will engage with the panel so you can shift it place and complete the reinstallation.

SOFT STRIDE FLOOR SYSTEM

The exclusive Soft Stride Floor System is available as a standard feature on the 4300, 4500, 5900, 6600, 6800, 6900 and SE45L Serenity models to provide a better grip, traction and comfort on both the steps and floor of the spa. Making your spa safe and easy to use while getting in and out.

Care & Maintenance Recommendations:

- Soft Stride Floor System cleans easily with soap, hot water and a brush (soft to medium bristle stiffness). Chlorine/bleach and water mixture, isopropyl rubbing alcohol or other household cleaners such as SoftScrub, Simply Green and 409 can be used to clean the pads.
- Be sure any soap or cleaning product is thoroughly rinsed from the pads and spa shell and this residue is removed before refilling the spa to prevent foaming.
- Always promptly attend to and clean any noticeable stains.

Never:

- Allow coloured anti-freeze to puddle or dry on the mat.
- Allow stains to develop without promptly being attended to and cleaned.
- Clean with acid based cleanly products.
- Use acetone or mineral spirits on the pads or spa shell as damage caused to the spa shell from these chemicals will void the warranty.

WINTERIZING YOUR HYDROPOOL HOT TUB

In the event that you do not wish to use your hot tub year-round, it is very important that you properly winterize it to protect against damage from freezing. Your **HYDROPOOL** retailer can perform this service for a nominal fee. If you choose to winterize your hot tub yourself, please follow the directions outlined below:

1. Drain the hot tub entirely. See section - **DRAINING YOUR HOT TUB**.
2. Remove and clean the filter cartridge. See section - **CARTRIDGE FILTER**.
3. Remove all of the jet inserts that are removable, any suction covers, water diverter cap(s) and waterfall control valve cap(s).
4. Using a wet / dry utility vacuum, remove remaining water from the jet openings, filter cartridge housing and footwell.
5. Using the blower side of the vacuum, position the blower nozzle into the top of the water diverter cap to blow out any water remaining in the plumbing lines so that the excess water will come out the jet bodies.
6. Replace all of the water diverter caps and waterfall control valve caps ensuring all gaskets are in place.
7. At the equipment end, loosen one union from each pump so that any excess water in each pump can be vacuumed out completely.
8. Either pour or use a turkey baster where necessary to add potable biodegradable RV antifreeze to areas such as pump wet ends, jet channels, filter housing and any blower channels.
9. Reinstall all jet inserts and all suction covers.

DO NOT USE AUTOMOTIVE ANTIFREEZE.

- **Important:** mixing potable biodegradable RV antifreeze with water significantly reduces its ability to protect against freezing. Therefore, it is very important ALL water is removed from the hot tub plumbing before adding.
- Add potable RV antifreeze to the holes in the bottom suction/drain to prevent any trapped water in the false floor from freezing and damaging the hot tub shell.
- Turn pump on for only a few seconds to circulate the antifreeze.
- Unthread and disconnect all unions in the support equipment area. Remove lowest winter drain plug on pump face plate. Repeat for all pumps, where applicable.

- Cover exposed plumbing connections with plastic bags and duct tape.
- Where practical, disconnect hot tub support equipment and store in a dry heated area.
- Install the safety hardcover, and cover the entire hot tub with a tarp to prevent premature weathering of the cabinet and the safety hard cover.
- Remove snow build up regularly to prevent damage to the safety hard cover.
- It is assumed that your **HYDROPOOL** hot tub has been properly installed on a reinforced concrete pad to eliminate lifting of the hot tub due to hydrostatic ground water pressure.



DRAIN PLUG LOCATIONS

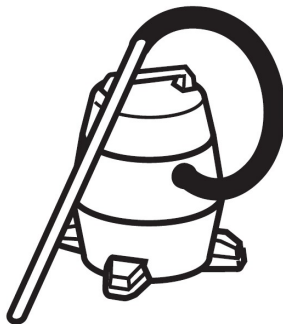

If you are not 100% confident that your hot tub is properly winterized, please consult your authorized HYDROPOOL Hot Tub Retailer. Caution recommends that an authorized Hydropole Retailer winterize your hot tub in the initial year. Damage as a result of freezing is not covered by the warranty.

GENERAL TROUBLESHOOTING

WHAT TO DO IN THE EVENT OF...

...POWER FLUCTUATIONS

The power supply into your home is, for the most part, fairly consistent. However, when local power demand is high, there is a tendency for the voltage entering your home to drop (sometimes significantly) or fluctuate. This condition is referred to as a 'brown-out'. Although safeguards have been built into the system to protect against this condition, supply voltage may drop low enough, if even for a second, to cause the system to display a 'ghost' message. Should this occur or if the display shows partial messages, try resetting the system by turning power to the hot tub off, waiting a few minutes, then turning power on again. If this does not reset the system, contact your local HydroPool retailer or service organization.

...POWER FAILURE OR SYSTEM FAULT DURING COLD WEATHER CONDITIONS

If your control system will not reset, (ie. GFCI trips) or if your pump will not circulate for any other reason, place a low wattage space heater under the cabinet in the equipment area. This will delay the risk of freezing while a service appointment is scheduled.



Always follow the manufacturer's instructions when locating and placing a portable electric space heater into service. Ensure that safe clearance to combustible surfaces is maintained. Do not leave unattended.

NOTES:

IN.YE-3 NA WIRING DIAGRAM

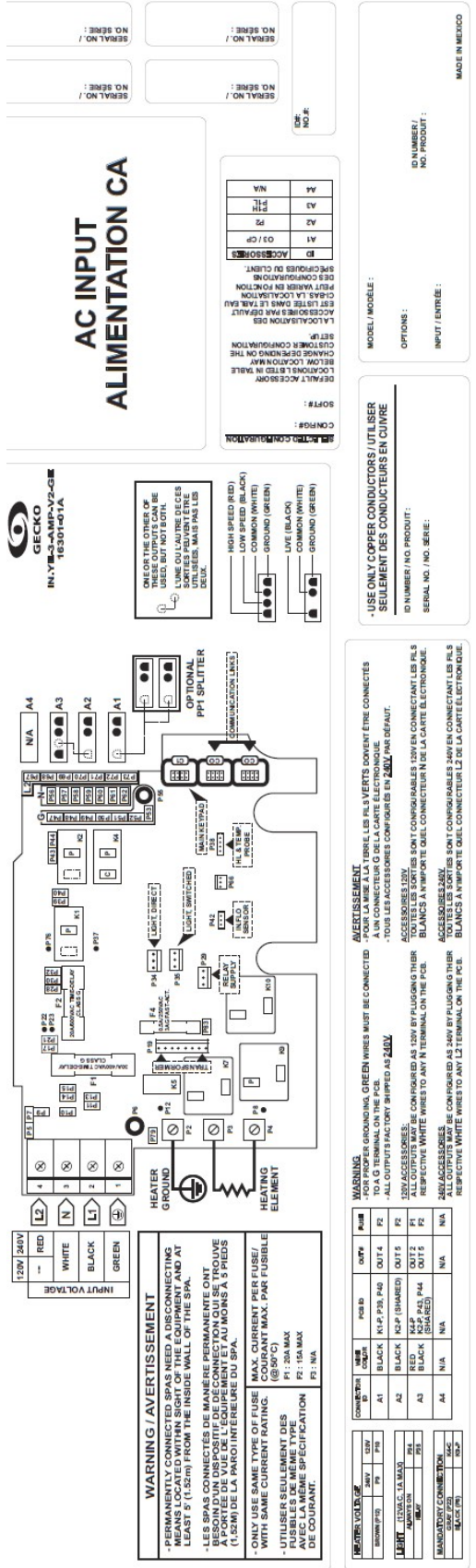

*** Pour toute modification, vérifier si des changements aux instructions d'assemblage sont à faire. ***

REV	DATE	PAGE	APP.
1	APR 16	C	CC
			
FILE NO.: 16301-01A LOGO: CONE/DRUM 12 PRINT DATE: APR 05, 2016 CONTOUR: APR 05, 2016 450, Dux Corporation 14150 872-4411 14150 872-0000 TEL: (419) 872-4411 FAX: (419) 872-0000			
DESCRIPTION: WIRING DIAGRAM IN.YE-3-AMP-V2-GE			
DESIGNED BY: C.CHAWA VERIFIED BY:			
DATE: APR 05, 2016			
APPROVED BY:			
DATE:			
QUANTITY: 1		PART NO.:	
NUMBER OF PAGES: 1		TOTAL OF 1 OF 1	